

Gateway 500S BT

General Installation Guide

G52-9202-5

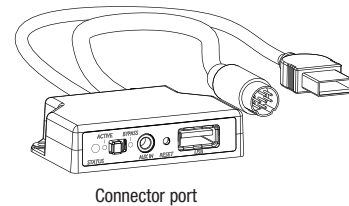
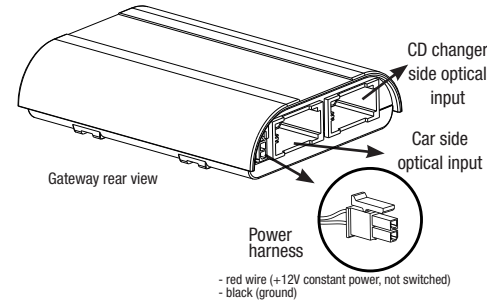
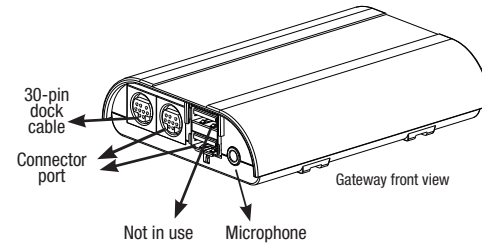

1. Introduction

The Dension Gateway 500S BT lets you connect your USB flash drive, iPod and iPhone to your original car radio, providing music playback and menu based control through your vehicle's entertainment system, using the original controls of the car stereo. The Gateway 500S BT also offers Bluetooth connectivity for A2DP music streaming and handsfree mobile call handling via the original buttons and screens of your vehicle.

Package content:

- Gateway interface
- Optical cable kit (MOST)
- Connector port
- Power harness
- Microphone (generic)

Optional accessories:

- Lightning cradle (IP6LCRP)
- Dension 30-pin dock cable (IPDC1GW)
- Dension 30-pin dock cable kit (IPO5DC9)
- iPhone Lightning to USB cable (IPLC1GW)
- 3.5 mm jack-jack cable (AUX-IN) (BLR1JJ1)
- DAB+G (DBG1GEN)

The Gateway 500S BT is available in 2 different hardware versions:

- Single FOT (GW52M01)
- Dual FOT (GW52M02)

Dual FOT version has two optical inputs: it is recommended for vehicles where original CD changer is available to retain that functionality (except in the case of the Audi MMI-2 High).

If there is no factory CD changer, then the Single FOT version Gateway is suitable. On the below picture you can see the connection options:

The most important factors of the installation are:

- Programming
- Gateway installation into the optical ring
- The factory CD changer
- The factory phone
- The 6 DIP switches on the Gateway

2. Programming

The Gateway 500S BT emulates a CD changer and uses the car's original CD changer controls to access offboard audio sources. Therefore it may be necessary to have the car programmed by your dealer in order to use the Gateway 500S BT with it.

Programming the car for Gateway 500S BT

Audi:

No programming required

BMW (non iDrive Professional, M-ASK & CCC Professional):

For programming we recommend to use our GEN2BME enabler tool or a 3rd party solution like Autologic. If you are not experienced with this, then please ask a service station for coding. For using all the functions of the Gateway you need to enable the "IPOD" option and the 644 phone option on the car.

Important notes:

- If there is a factory phone installed, then please also go to: Section 6: "Phone"
- If the software version of the car's head unit dates before 2005, then please update it before programming!

Mercedes-Benz

Generally no programming is required but if there was no device on the the optical ring installed, then the CD changer option needs to be coded with the service computer.

Porsche

If there is no CD changer installed, then you need to program the CD changer option.

3. Device installation

After successful programming you can start with the installation.

Please note: Installation of the Gateway 500S BT is very complex, therefore please have it installed by a professional installer.

There are different installation types, all of them are basically for the Single FOT version Gateway, but they are also possible with the Dual FOT Gateway. If there is the Dual FOT version and you don't use the right (CD changer side) optical input of it, then you need to put an optical loop on this connection. (You can create an optical loop by using the second optical cable of the Gateway's package.)

The only exception is "Type 2a" where ONLY the Dual FOT version Gateway can be used and you apply both optical connections of the Gateway device.

Important note: When you connect the power harness please make sure that you feed the Gateway device with **+12V non-switched constant power**.

Installation Type 1 (Fig. 1):

Vehicles that support two CD changers on the optical ring as an original function.

- Audi A4/S4/RS4/A5/A6/S6/RS6/A8/S8/Q7 with MMI-2 High (colour)

These vehicles allow you to select between Gateway audio sources and the original CD changer through the existing car audio controls without using the Connector port.

Installation: You add the Gateway to the optical ring as you can see on Fig. 1 - the MMI-2 High system will recognise it as a second CD changer:

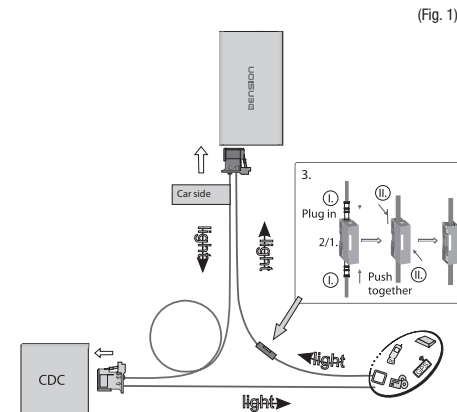

(Fig. 1)

Installation Type 2a (Fig. 2):

Vehicles with an existing CD changer.

This installation type is possible with Dual FOT version Gateways only. This allows you to select between Gateway audio sources and the original CD changer by switching between ACTIVE (Gateway) and BYPASS (CD changer) mode with the Connector port. (For exact information please read: "5. Connector port")

Installation:

1. First please remove the CD changer
2. Then install the Gateway on the remaining place of the CD changer on the optical ring
3. Finally install the CD changer into the second (CD changer side) optical input of the Gateway

(Fig. 2)

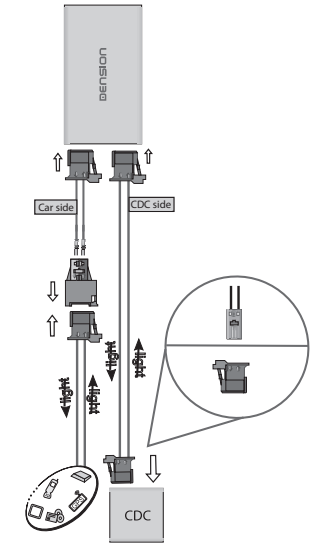

Please note: Vehicles that have the original CD changer in the trunk it is recommended to use the FOA1P01 optical extension kit so that the Gateway's hardware can be placed to the front part of the car (behind the radio or in the glove box).

Installation Type 3a (Fig. 3):

Vehicles with no existing CD changer. Choose this type if there is no CD changer in the car.

Installation: Please install the Gateway as the last device on the MOST ring or in other words it needs to be connected behind the head unit (radio). Please make sure that you don't disconnect the other elements of the optical ring by doing this process (for example the amplifier of the car).

(Fig. 3)

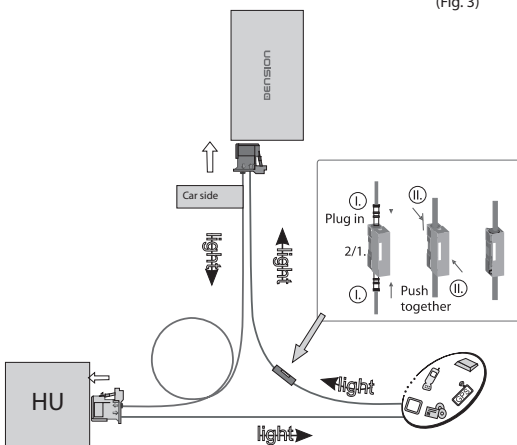

Installation Type 3b (Fig. 4):

Vehicles with no existing CD changer, but with a free fiber optic connector (CD changer preparation). Choose this type if there is no CD changer in the car, but only a free CD changer preparation. Installation: You can install the Gateway directly in the CD changer preparation:

(Fig. 4)

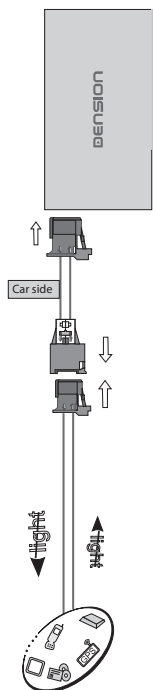

4. DIP switch settings

Set the DIP switches according to you car type:

Audi (MMI-2 High & Basic)

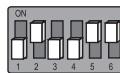

Text capable BMW E87, E90, E91, E92, E93, E60/61, E63/E64 & E70

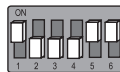

Porsche (PCM I/II/2.1)

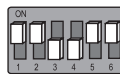

Mercedes (NTG1-, NTG2- Comand)



Please note: Before changing the DIP switch settings, please turn off the car and remove the power harness of the Gateway. After this, please wait 5 minutes, reconnect the gateway and start the car

If you would like to use the factory phone option instead of the Gateway's phone functions, please use one of the next DIP settings:

Audi (MMI-2 Basic Monochrome)

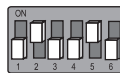

Text capable BMW E87, E90, E91, E92, E93, E60/61, E63/E64 & E70

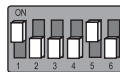

Porsche (PCM I/II/2.1)

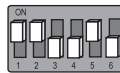

Mercedes (NTG1-, NTG2- Comand)

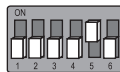

5. Connector port

The connector port is a convenient accessory and extension for USB and AUX input (3.5mm jack), that also has a mode selector switch and a reset button. Use the mode selector switch to set the Gateway in bypass mode, if needed. (For further information please check the user manual!)

This is how you connect it to the Gateway:

The connector port has a USB and a 9-pin connector, please plug them into the right side 9-pin and into the bottom USB input of the Gateway (as you can see this on the first diagram of "1. Introduction"). Please also make sure that the mode switch is set to active mode - later you can change the setting.

6. Phone

Compatibility (minimum requirements):

- Porsche with PCM 2 / 2.1 Head Units, where 'Phone' button exists
- Audi with MMI High and Basic Head Unit with steering wheel control buttons
- BMW 1/3/5/6/X5
- Mercedes (NTG 1 & NTG 2) Comand Head Units

Remove the factory phone from the MOST ring and put an optical loop on its remaining place (if factory phone module is present) if the Gateway 500S BT will be used for phone functions.

Please note: If it is needed, enable the factory telephone module with a diagnostic computer. (See more at: "2. Programming")

If you want to use the original phone module of the car instead of the Gateway's phone functions, then please leave the factory phone in the optical ring and turn the 6th DIP switch on the bottom of the Gateway into OFF position as you can see it in "5. DIP switch settings". It is still possible to use the A2DP function of the Gateway when the phone function is disabled by the DIP switch setting.

7. Fitting the microphone

The 3.5mm jack connector on the hardware is dedicated for the microphone of the Gateway which is used for hands free. The microphone will work best when it is kept away from all noise sources (open windows or speakers) and close to the driver. So the best place to ensure perfect sound is to install at the central interior light or rear view mirror in the centre of the windscreen. There are clips that help you mounting the microphone. The optimal place for the microphone depends on many factors, so it is recommended that you try different installation places before finalizing the microphone installation.

9. Disclaimer

If your car's electrical system begins to behave in an unpredictable way please immediately disconnect the Gateway device physically and have it checked by your installer or an automotive electronics professional. Dension and its authorized distributors and retailers are not liable for any incidental consequential or indirect damages or loss and do not assume liability for any diagnostic fees.

The use of handheld devices while driving may be subject to government legislation. Please ensure that your use of the Dension device complies with applicable traffic laws. Dension does not assume liability for any events resulting from the illegal or irresponsible use of handheld devices during the driving. Dension reserves the right to modify its products or specifications without prior notice.

10. Warranty

Dension devices carry a one-year limited warranty that protects you from defects in material and workmanship of products sold by Dension or its authorized distributors and retailers. Dension does not warrant any installation work or assume liability for any damage caused due to negligence, improper installation or operation. For warranty claims, proof of purchase is required.

11. Update and support

If you need further assistance in using your Gateway, please contact your local supplier or visit www.dension.com. Please check the product section for the latest firmware version and product documentation of your device.

8. Troubleshooting

Symptom	Cause	Solution
Status LED is OFF constantly on the Connector port	There is a break on the MOST ring or missing power	Check the installation, make sure that the light directions and the optical connections are fine
Gateway is not recognised	Wrong DIP switch settings or the CD-changer function is not activated	Check the DIP switch, program the required function (check section "2. Programming")
Amplifier (you can't hear the sound of the music) or other factory device is not available when Gateway is in active mode	Mute wire is not connected to the radio	Please connect the mute wire according to the installation guide
Remote control is not working in Bluetooth audio mode	Bluetooth settings of the phone might be incorrect	Close all running application, delete pairing history, reboot the phone and pair it again.
CD source option or CD magazines are greyed out (on BMW)	Programming issue	The car needs to be programmed. (check section "2. Programming")
Always starts in AUX mode or the phone needs to be paired at startup or always the first track is being played at startup from USB	Wrong power connection type	Make sure that the power is constant 12V
NO text display when iPod GW mode or USB source selected (on Audi)	Wrong MMI settings	Check the CD-changer settings on your MMI Menu and enable CD Text option
NO text display when iPod is connected	iPod UI is selected	Change the iPod mode to iPod Gateway mode